



The Accu-CT ACTL-1250 series split-core current transformers provide revenue-grade accuracy with a 0.33333 volt or 1.0 volt AC output.

Features

- Rated currents: 250, 400, and 600 amps
- Excellent gain linearity and low phase angle error
- Integral burden resistor, no shorting block needed
- Optional revenue-grade: 0.6% accuracy
- Opening: 1.83 x 1.26 in. (46.5 x 32.0 mm)
- Handles two 350 kcmil or one 750 kcmil conductor
- Can be wired in parallel
- UL Listed (UL 2808, XOBA)
- Revenue models include certificate of calibration

Links

- **Product page:** <https://ctlsys.com/product/accu-ct-act-1250-split-core-ct/>
- **Manual:** <https://ctlsys.com/wp-content/uploads/2017/04/ACTL-1250-CT-Manual.pdf>
- <https://ctlsys.com/support/measuring-parallel-conductors/>

Patents

- U.S. Patent 8,847,576

1 Models and Options

Table 1: Models

Model	Rated Amps	Maximum Continuous Amps	Output at Rated Amps	Line Frequency	Nominal Gain Accuracy	Nominal Phase Accuracy	Internal Burden (Ohms)
ACTL-1250-250	250 A	720 A	0.33333 Vac	50-60 Hz	±0.75%	±0.50°	8.00
ACTL-1250-400	400 A	720 A	0.33333 Vac	50-60 Hz	±0.75%	±0.50°	5.00
ACTL-1250-600	600 A	720 A	0.33333 Vac	50-60 Hz	±0.75%	±0.50°	3.33
ACTL-1250-250 Opt C0.6	250 A	720 A	0.33333 Vac	50-60 Hz	±0.50%	±0.25°	8.00
ACTL-1250-400 Opt C0.6	400 A	720 A	0.33333 Vac	50-60 Hz	±0.50%	±0.25°	5.00
ACTL-1250-600 Opt C0.6	600 A	720 A	0.33333 Vac	50-60 Hz	±0.50%	±0.25°	3.33
ACTL-1250-250 Opt 1V	250 A	600 A	1.000 Vac	50-60 Hz	±0.75%	±0.50°	24.0
ACTL-1250-400 Opt 1V	400 A	600 A	1.000 Vac	50-60 Hz	±0.75%	±0.50°	15.0
ACTL-1250-600 Opt 1V	600 A	720 A	1.000 Vac	50-60 Hz	±0.75%	±0.50°	10.0
ACTL-1250-250 Opt 1V,C0.6	250 A	600 A	1.000 Vac	50-60 Hz	±0.50%	±0.25°	24.0
ACTL-1250-400 Opt 1V,C0.6	400 A	600 A	1.000 Vac	50-60 Hz	±0.50%	±0.25°	15.0
ACTL-1250-600 Opt 1V,C0.6	600 A	720 A	1.000 Vac	50-60 Hz	±0.50%	±0.25°	10.0

Note: ACTL-1250 part numbers are exactly equivalent to ACT-1250 parts.

Note: the ACTL-1250 is also available in an Opt C0.3 (0.3% accuracy) version. This is documented in a separate datasheet.

Note: the burden resistor is built into the ACTL-1250.

1.1 Options

1.1.1 Opt C0.6

With Option C0.6, the Accu-CT meets IEEE/ANSI C57.13-2008 class 0.6 accuracy and IEC 60044-1 class 0.5 and class 0.5 S accuracy from -30°C to 55°C and from 1% to 120% of rated primary current.

- Accuracy improves from $\pm 0.75\%$ to $\pm 0.5\%$.
- Phase angle improves from ± 0.50 degrees to ± 0.25 degrees.
- Includes a serialized certificate of calibration unless ordered with Opt C0.6,N.

1.1.2 Opt C0.3

Option C0.3 provides IEEE C57.13 class 0.3 accuracy and is documented in a separate datasheet: "ACTL-1250-C0.3-Datasheet".

1.1.3 Opt FT

The Accu-CT can be ordered with custom lead lengths. For example, Opt FT=20 for 20 foot leads. We also sell extra lead wire to allow for field extension of the leads. Option FT does not affect the accuracy specifications.

1.1.4 Opt M

The Accu-CT can be ordered with custom lead lengths. For example, Opt M=4 for 4 meter leads. We also sell extra lead wire to allow for field extension of the leads. Option M does not affect the accuracy specifications.

1.1.5 Opt 1V

1.000 Vac (1000.0 mVac) full-scale output voltage. The one volt output is NOT compatible with WattNode meters.

Note, models with Opt 1V may have lower maximum continuous amps ratings. See **Table 1: Models** for details.

1.1.6 Opt HF

This option improves the high frequency performance by eliminating the phase angle compensation capacitance.

- Very flat frequency response up to 10 kHz.
- No change to the gain accuracy.
- The nominal phase angle error increases by approximately 0.25 degrees (15 minutes). The phase angle curve remains very flat from 1% to 120% of rated primary current.
- Due to the increased phase angle error, this option no longer meets IEEE C57.13 accuracy requirements. This option is not available with Opt C0.6.

2 Specifications

- **Nominal Line Frequency:** 50 to 60 Hz
- **Maximum Continuous Primary Current:** See **Table 1: Models**
- **Maximum Voltage:** 600 Vac
- **Overvoltage and Measurement Categories:**
 - 600 Vac, CAT IV (service entrance) for pollution degree 2
 - 250 Vac, CAT III for pollution degree 3
- **Output Lead Wires:**
 - **Standard length:** 8 ft (2.4 m)
 - **Gauge:** #18 AWG
 - **Type:** MTW, UL 1015
 - **Voltage:** 600 Vac
 - **Temperature Rating:** 105°C
 - **Style:** Two conductor: white and black, twisted
- **Output:** Voltage output, integral burden resistor
 - **Output Voltage at Rated Amps:** see **Table 1: Models**
 - **Output Protection:** includes internal burden resistor and 9V Zener diode

- **Expected Load Resistance:** (see **Effect of Output Loading** section)
 - **All Except Opt 1V Models:** 23kΩ
 - **Opt 1V Models:** 1.0MΩ

2.1 Accuracy

- **Standard Output Accuracy:**
 - **Accuracy (% of reading):** ±0.75% from 1% to 120% of rated current
 - **Phase Angle:** ±0.50 degrees (30 minutes) from 1% to 120% of rated current
 - **IEEE C57.13 Accuracy:** class 1.2 from 1% to 120% of rated current
 - **IEC 60044-1 and IEC 61869-2 Accuracy:** class 1.0 from 1% to 120% of rated current
- **Opt C0.6 Output Accuracy:**
 - **Accuracy (% of reading):** ±0.50% from 1% to 120% of rated current
 - **Phase Angle:** ±0.25 degrees (15 minutes) from 1% to 120% of rated current
 - **IEEE C57.13 Accuracy:** class 0.6 from 1% to 120% of rated current
 - **IEC 60044-1 and IEC 61869-2 Accuracy:** class 0.5 and 0.5S from 1% to 120% of rated current
- **Opt HF Output Accuracy:**
 - **Accuracy (% of reading):** ±0.75% from 1% to 120% of rated current
 - **Phase Angle:** +0.75, -0.25 degrees (+45, -15 minutes) from 1% to 120% of rated current
- **Opt 1V Output Accuracy:** same as either standard or Opt C0.6 accuracy
- **Conductor Position Sensitivity:** typical ±0.06%, maximum ±0.10%
 The quoted gain accuracy is with the measured conductor centered in the CT opening. Moving the conductor off-center may cause small accuracy errors. The following diagram shows the typical errors at different positions. The phase angle error varied by less than 0.01 degree at varying positions.

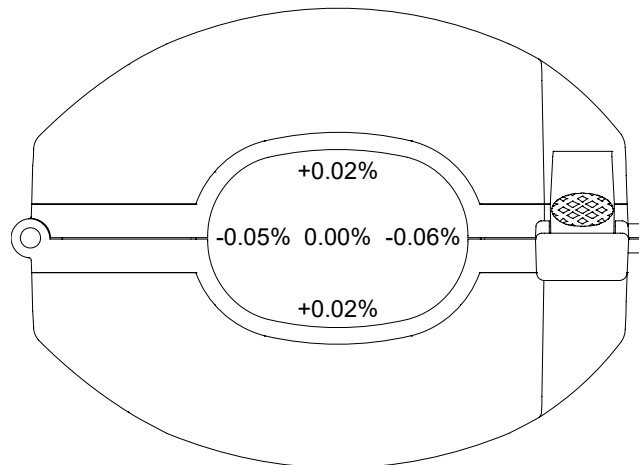

2.2 Regulatory

- **CE**
- **UL:** UL listed, XOBA, UL 2808, CAN/CSA-C22.2 No. 61010-1, E363660
- **RoHS Compliant**

2.3 Environmental

- **Operating Temperature:** -30°C to +75°C (-22°F to 167°F)
- **Operating Humidity:** Non-condensing, 5 to 95% relative humidity (RH)
- **Operating Altitude:** Up to 3000 m (9842 feet)
- **Pollution Degree:**
 - 2 (controlled environment) for CAT IV, 600 Vac
 - 3 (harsh environment) for CAT III, 250 Vac
- **Indoor Use:** Suitable for indoor use
- **Outdoor Use:** Suitable for outdoor use when mounted in a NEMA 3R or 4 (IP 66) rated enclosure, provided the ambient temperature will not exceed 75°C (167°F)

2.4 Mechanical

- **Width:** 4.50 in. (114.0 mm ± 1.0 mm)
- **Height:** 3.30 in. (83.4 mm ± 1.0 mm)
- **Thickness:** 1.58 in. (40.2 mm ± 0.5 mm)
- **Opening:** 1.83 x 1.26 in. (46.5 x 32.0 mm ± 0.5 mm)
- **Weight:** 13.9 oz (395 gm)
- **Housing Material:** PC/ABS, 94V-0 flame rating
- **Core Material:** high permeability ferrite

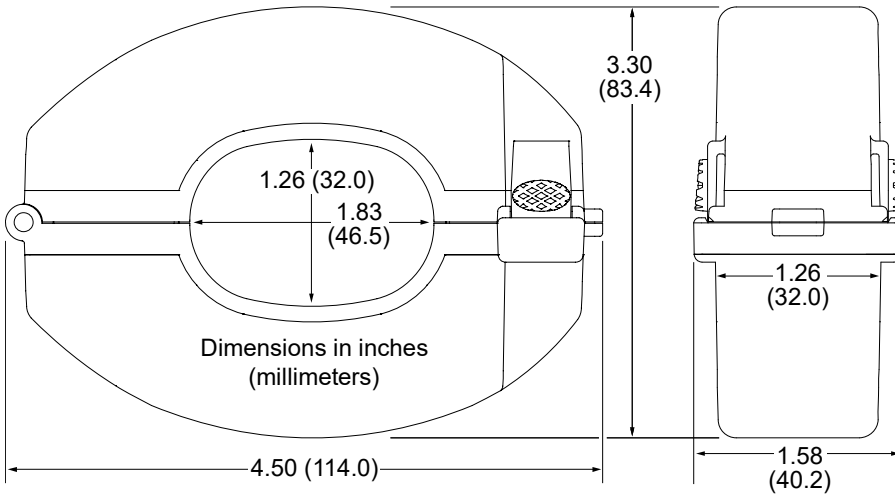

2.5 Miscellaneous

- Assembled in USA
- **Label barcode:** QR Code, "Model ; SerialNum"

3 Typical Accuracy

In the following graphs, a positive phase angle error indicates that the output of the CT leads the primary current.

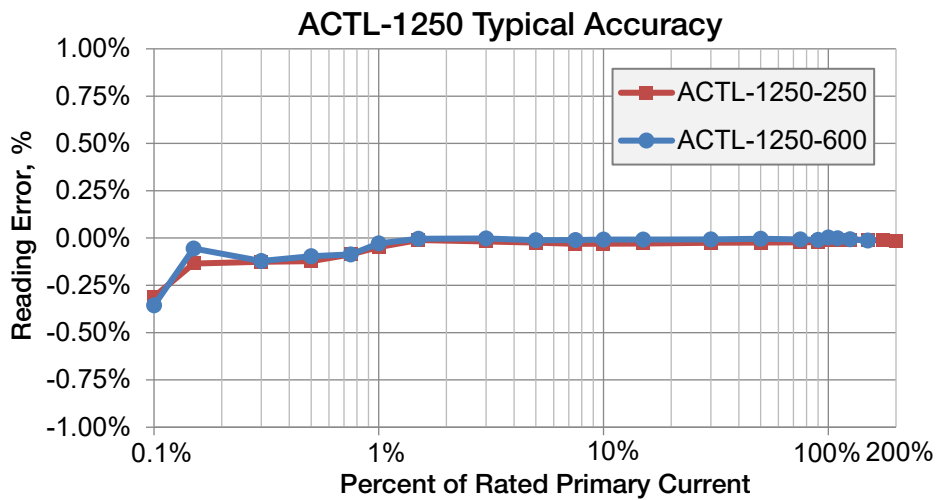

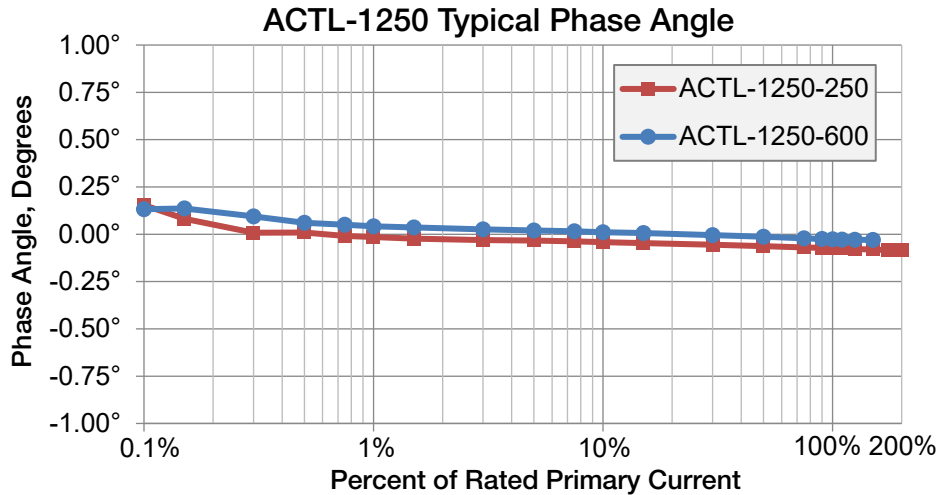

3.1 Effect of Output Loading

If you are using the ACTL-1250 series current transformers with a WattNode meter, you may disregard this section because the ACTL-1250 CTs have been optimized for the standard 23kΩ loading of a WattNode meter. For anything other than a WattNode meter, the meter’s input impedance may affect the gain of the CT, because the meter’s input impedance appears as an output load to the current transformer.

The ACTL-1250 series current transformers are designed with an expected output loading: 23kΩ for all models except Opt 1V; the expected loading is 1.0MΩ for Opt 1V models. Different actual loadings will cause small shifts in the gain. A higher load than expected will result in higher gain, while a lower load will result in a lower gain. The phase angle error is not materially affected by the loading.

For all models except Opt 1V, the worst-case effect of different loads follow:

- 1.0MΩ load: gain will be high by 0.06% or less
- 10kΩ load: gain will be low by 0.08% or less.

To precisely compute the effect of non-standard output loadings, use the following.

R_B = Internal Burden Resistance (see **Table 1: Models**)

R_D = Designed Output Loading (either 23kΩ or 1.0MΩ)

R_A = Actual Output Loading

$e\%$ = Gain Error (percentage)

$$e\% = 100 \frac{R_B(R_A - R_D)}{R_D(R_B + R_A)}$$

$$e\% \cong 100 \frac{R_B(R_A - R_D)}{R_D R_A}$$

Examples:

ACTL-1250-400 with 10kΩ load: $R_B = 5, R_D = 23000, R_A = 10000, e\% = -0.028\%$ (low)

ACTL-1250-400 with 1.0MΩ load: $R_B = 5, R_D = 23000, R_A = 1,000,000, e\% = +0.021\%$ (high)